

HighLite 50W

Part nr: 140001

Product information

A cost-effective outdoor lamp with strong UV resistance and anti-corrosion, built for harsh environment. Universal mounting bracket and angle adjustment makes the installation quick and easy. The new hollow design lets the heat upwards and away from the LED light source. The radiator on the backside leads the rainwater away and prevents water accumulation.



Specifications

Voltage	230V
Width x Height x Depth	252,6 mm x 337 mm x 55,2 mm
Brightness	7000 lm
Power	50W
Efficacy	140lm/W ±10
Colour temperature	4000K
Beam angle	90°
IP class	IP67
IK	09
CRI	>70
Ambient temperature	-30°C to + 50°C
LED type	SMD5050
Lifetime	102.000 hours (L70)
Dimmable	No
Gross weight	2,16kg
Certificates	CE, RoHS
Warranty	5 years



Used electrical and electronic products, including all types of batteries, must be delivered for recycling at a separate collection point. (acc. to directive 2012/19/EU and 2006/66/EC).

Construction

Body material	Aluminium
Optic material	Polycarbonate
Lens material	Toughened glass
Bracket material	Galvanized iron
Color	Black

HighLite 50W

Part nr: 140001

ENG

Dimensions

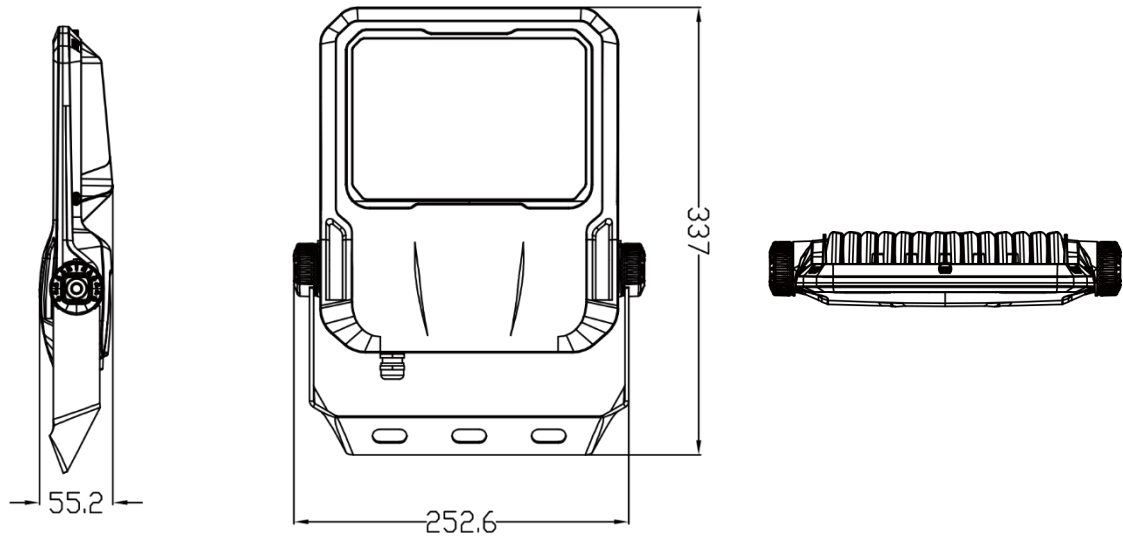

Photometric diagrams

